

REGULATED DC POWER SUPPLY

UTP1303/UTP1305

UTP3303/UTP3305

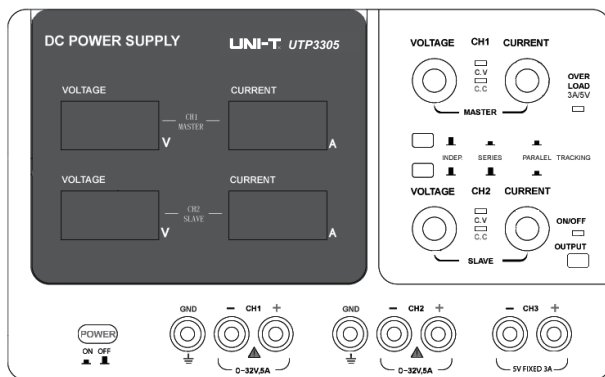
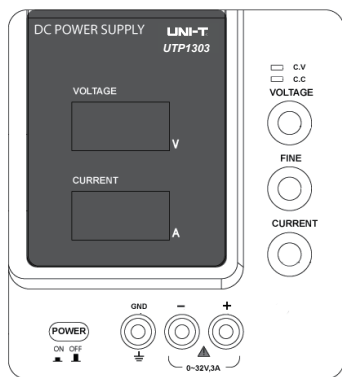

Only illustrative image

UNI-T®

INSTRUCTIONS MANUAL

Index

1. Safety Notes	02
1.1 Symbols and Safety Terms	02
2. Introduction	03
3. Specifications	04
3.1 General Specifications	04
3.2 Electrical Specifications	04
4. Panel Description	06
5. Operation	09
5.1 Precautions	09
5.2 Connection Mode Settings	09
5.3 Limit Current Adjustment	10
5.4 Constant Voltage / Constant Current Feature	10
5.5 Single Operation Mode	11
5.6 Parallel Operation Mode	12
5.7 Series Operation Mode	13
5.8 Symmetric Operation Mode	13
6. Maintenance	14
6.1 Fuse Replacement	14
6.2 Power Supply Voltage Selection	15
6.3 Cleaning	15
7. Accessories	15

1. SAFETY NOTES

- Carefully read the informations of this Instruction Manual before using the instrument.
- Never uses the instrument in anomalous conditions (explosive atmosphere, flammable gases, smoke, vapor or dust); with the connection cables without insulation or broken; or with the instrument open.
- During the perform, do not touch in wires without insulation, connectors or any other live part of the electrical circuit. In case of doubt, check the circuit voltage before touch it.
- Be extremely careful when working with electrical circuits that presents voltages above 30V DC or 24V AC, specially in high power circuits when accidents can be fatal.
- Never exceed the specified limits of the instrument.
- Do not input any external voltage to the output terminal to avoid damages to the instrument.
- The repairs, part replacements and calibration must be performed only by qualified personnel. Excepting the fuse replacement and the power supply voltage selection.
- If the instrument is used in a way not specified by the manufacture, the provided protection by the instrument can be impaired.
- Do not use the equipment on places exposed to severe vibrations or high magnetic fields such as close to motors.
- Do not put objects above the case, specially if it contain liquids.
- Do not obstruct the ventilation holes or insert objects in it.
- Avoid to utilize the instrument on extremely hot or cold places and principally do not use the instrument immediately after bring it of a cold place. Wait for the thermal stabilization. Similarly do not move the instrument of hot places to a cold places, avoiding an internal condensation problem.

1.1 Symbols and Safety Terms



Caution (refers to the documents that provide informations related to safety).



Protection Conductor Terminal.



Hot Surface

CAUTION

Used to indicate the correct operation or maintenance procedures, avoiding damages or destruction of the instrument or other properties.

WARNING

Identify the potential hazards that requires correct procedures and practices to avoid personnel injuries.

2. INTRODUCTION

These regulated power supply manufactured by Minipa was designed to supply the frequent needs of research and developing laboratories, schools, maintenance centers and assembly lines. The UTP1303 and UTP1305 are single variable power supplies with only one output and the UTP3303 and UTP3305 are power supplies with two variable output and one special fixed output(5V).

Among the features of these power supplies, we can emphasize.

- High stability and low ripple.
- Display with easy reading for simultaneous presentation of voltage and current output.
- Voltage and Current adjustment through variable devices with high precision.
- Coarse and fine voltage and current adjustment. (available for UTP1303 and UTP1305).
- Settings of the Operation Mode (series and parallel) through the front panel (available for UTP3303 and UTP3305).
- Button to able the outputs. (available for UTP3303 and UTP3305)
- Possibility of continuous operation even on full loaded conditions.
- Cooling with forced ventilation.
- Overload Protection Circuit.

Comparative Table

Features	UTP1303	UTP1305	UTP3303	UTP3305
Variable Output	1 x 0~32V 1 x 0~3A	1 x 0~32V 1 x 0~5A	2 x 0~32V 2 x 0~3A	2 x 0~32V 2 x 0~5A
Fixed Output	-		5V / 3A	
Maximum Consumption (W)	200	300	450	700
Dimension H x W x D (mm)	140 x 160 x 260		170 x 260 x 315	
Approx. Weight (kg)	5.0	5.5	9	10

3. SPECIFICATIONS

3.1 General Specifications

- Power Source: 115V/230V \pm 10% - 50/60Hz (selectable)
- Internal Usage
- Altitude: 2000m (maximum)
- Pollution Degree: 2
- Consumption:
 - 200W (Max.) to UTP1303
 - 300W (Max.) to UTP1305
 - 450W (Max.) to UTP3303
 - 700W (Max.) to UTP3305
- Operation Environment: 0°C to 40°C, RH 10 ~ 80%
- Storage Environment: -20°C to 60°C, RH 10 ~ 80%
- Dimension:
 - 140(H) x 160(W) x 260(D)mm (UTP1303 and UTP1305)
 - 170(H) x 260(W) x 315(D)mm (UTP3303 and UTP3305)
- Approx. Weight:
 - 5.0kg UTP1303
 - 5.5kg UTP1305
 - 9kg UTP3303
 - 10kg UTP3305

3.2 Electrical Specifications

The contact and cable resistances influence the specifications. Therefore, try to minimize it, as well using auxiliary external connections in the tracking modes (Series and Parallel), even if there already exists an internal commutation.

- Constant Voltage Operation:

Model:		UTP1303	UTP3303	UTP1305	UTP3305
Output (continuously adjustable):		0 ~32V			
Regulation	Line:	$\leq(0.01\%+3mV)$			
	Load:	$\leq(0.01\%+3mV)$			
Ripple and Noise:		$\leq 1mV$ RMS			

- Constant Current Operation:

Model:		UTP1303	UTP3303	UTP1305	UTP3305
Output (continuously adjustable):		0 ~ 3A		0 ~ 5A	
Regulation	Line:	$\leq(0.1\%+3mA)$		$\leq(0.1\%+5mA)$	
	Load:	$\leq(0.2\%+3mA)$			
Ripple and Noise:		$\leq 3mA$ RMS			

- Recovering time for load exchange: 1ms.
- 5V Fixed output (available to UTP3303 and UTP3305):

Model:		UTP3303	UTP3305
Current Output:		3A	
Regulation	Line:	$\leq \pm 5\text{mV}$	
	Load:	$\leq \pm (3\%+5\text{mV})$	
Ripple and Noise:		$\leq 2\text{mV RMS}$	

- Tracking Error (available for UTP3303 and UTP3305): $\leq 300\text{mV}$
- Display:

Digital:		3 digits
Precision:		$\leq \pm (1.0\% \text{ Rea.} + 2 \text{ Dig.})$
Resolution of	Voltage:	100mV
	Current:	10mA

- Led Indicators:
Green Led to Continuous Voltage (CV)
Red Led to Continuous Current (CV)
Red Led to Overload Indication (just for fixed outputs of 5V / 3A)
- Cooling Method: Forced cooling activated by temperature
- Insulation:

Maximum Voltage to earth:		$\pm 200\text{V}$
Case	Output Terminal:	$\leq \pm 30\text{M}\Omega (500\text{Vdc})$
	AC Cable:	$\leq \pm 30\text{M}\Omega (500\text{Vdc})$

- Overload Protection.
- Polarity Inversion Protection.

4. PANEL DESCRIPTION

Frontal Panel

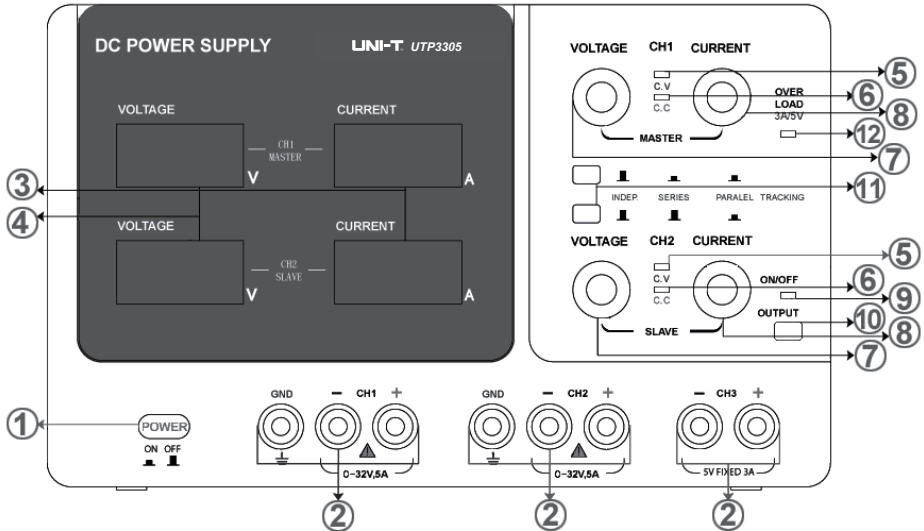

Figure 1 – Front Panel: Models UTP3303 / UTP3305

1. ON / OFF Key
2. Earth Terminals (Ground), Negative and Positive Output.
3. Current Output Displays.
4. Voltage Output Displays.
5. Indicator of Constant Voltage Operation Mode (C.V.).
6. Indicator of Constant Current Operation Mode (C.C.).
7. Control to adjust Output Voltage.
8. Control to adjust Output Current.
9. Indicator of Active Output.
10. Key for Output Abling.
11. Key for selecting the Connection Mode (Series or Parallel).
12. Indicator of the Power Source 5V / 3A Overload.

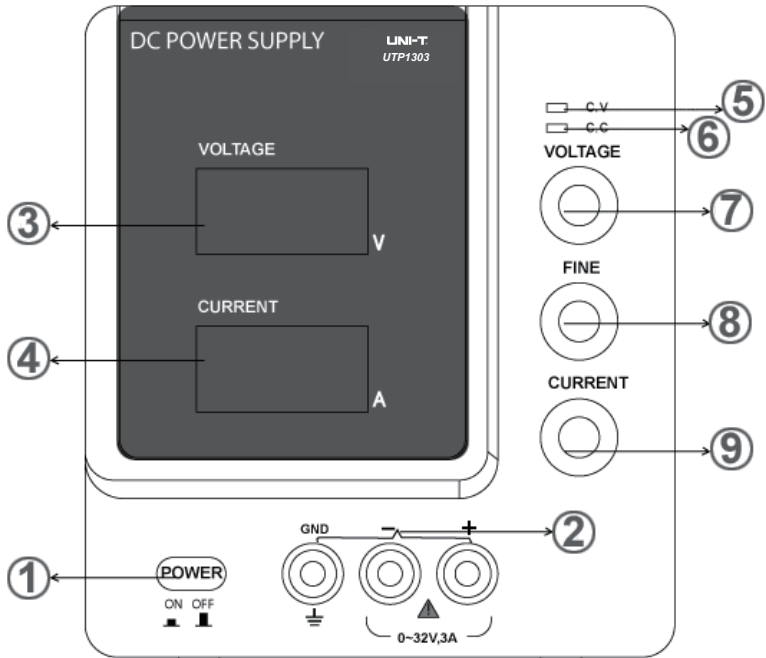

Figure 2 – Front Panel: Models UTP1303 / UTP1305

1. ON / OFF Key
2. Earth Terminals (Ground), Negative and Positive Output.
3. Voltage Output Displays.
4. Current Output Displays.
5. Indicator of Constant Voltage Operation Mode (C.V.).
6. Indicator of Constant Current Operation Mode (C.C.).
7. Coarse Control to adjust Output Voltage.
8. Fine Control to adjust Output Voltage.
9. Control to adjust Output Current.

Rear Panel

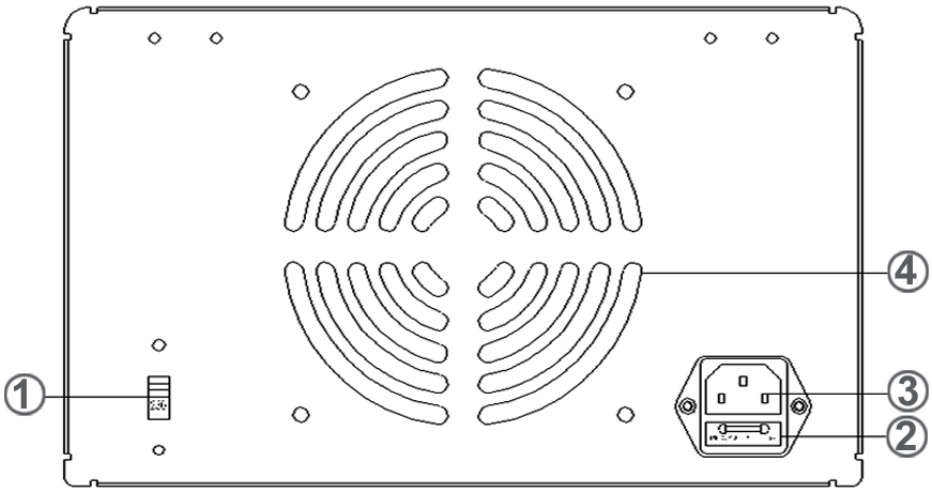

Figure 3 – Rear Panel: Models UTP3303 / UTP3305

1. Power Supply Voltage Selection Switch.
2. Fuse holder.
3. Power Supply Input Socket.
4. Ventilation Opening.

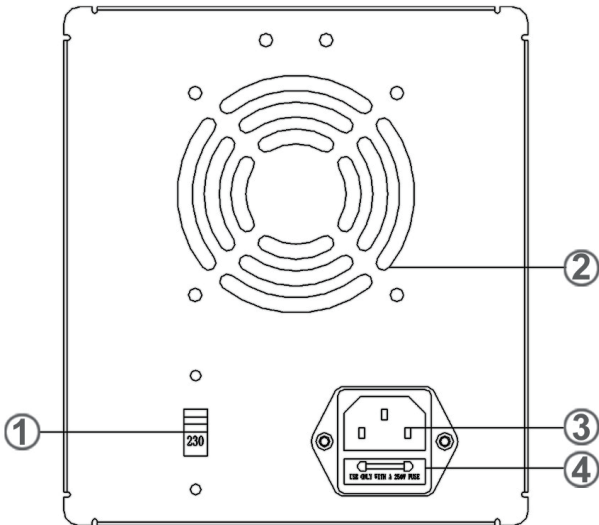

Figure 4 – Rear Panel: Models UTP1303 / UTP1305

1. Power Supply Voltage Selection Switch.
2. Ventilation Opening.
3. Power Supply Input Socket.
4. Ventilation Opening.

5. OPERATION

5.1 Precautions

1. The input AC power voltage of the instrument must be within the ranges of 115V RMS \pm 10% or 230V RMS \pm 10%, 50/60Hz. Refers to the table "Fuse Replacement" because each input voltage range corresponds to a proper fuse specification.
2. To avoid possible electrical shocks at contact with the power supply case. It is recommended to use the effective ground of the instrument (3^o of power cable, round pin) that should be connected to an effective ground, do not use the neutral conductor of outlet for this.
3. Avoid to use the instrument in environments exposed to temperature over 40°C. The cooling device located on the instrument rear panel must be positioned to places with good ventilation.

5.2 Connection Mode Settings (available to UTP3303 and UTP3305)

The selection keys of the Connection Mode (known as Tracking Keys) has the function of switch the connection mode between the power supplies according to his associations. The tracking settings of the Single, Series and Parallel modes are illustrated below:



Figure 5 – Connection Mode Settings

5.3 Limit Current Adjustment

1. Define safely the limit current to the device or circuit to be supplied.
2. Make sure that the power source voltage is equal to the selected voltage of the selection switch, so connect the power cable between the outlet and the power supply and turn it on.
3. Adjust the VOLTAGE control to a voltage between 0.5 and 5V.
4. Temporarily short-circuit the power supply terminals (+) and (-) with the provided connection cables.
5. Adjust the CURRENT control to obtain the defined limit current previously (item 1) through the reading of the Current Output Display.
6. The limit current (Overload Protection) is already adjusted. Do not change the CURRENT control after this step.
7. Remove the short-circuit between the terminals (+) and (-) and adjust the desired voltage.
8. Connect the power supply, now adjusted, to the device or circuit to be supplied.

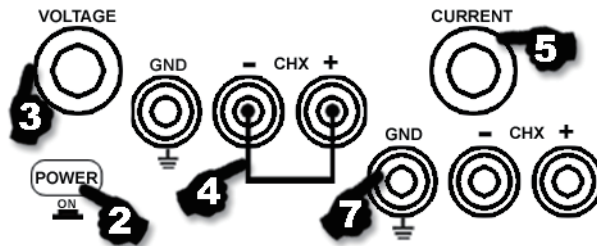

Figure 6 – Limit Current Adjustment

Notes:

The previously procedures can be performed individually for each one of the adjustable power supplies of the models UTP3303 and UTP3305, as well as to the models UTP1303 and UTP1305.

Remember that when the load requires a higher current than the adjusted limited, the power supply starts to decrease automatically the supplied voltage, and keeps the limit current adjusted (constant current is displayed by the indicator C.C).

5.4 Constant Voltage / Constant Current Features

The working feature of these instrument is called automatic constant voltage / current crossover. It allows a continuous transition of the constant current mode to the constant voltage in response to the load variation. The intersection of the constant voltage and constant current modes is called crossover point. The Figure 7 illustrate the relationship between the crossover point and the load.

For example, if the load is such the power supply operates in constant voltage mode, so a regulated output voltage is supplied. This output voltage keeps constant with the increasing of the load till the point that the adjusted limit current is reached. At this point, the current becomes constant and the voltage starts to decrease proportionally to the load increasing. This point is indicated by C.V and C.C indicators.

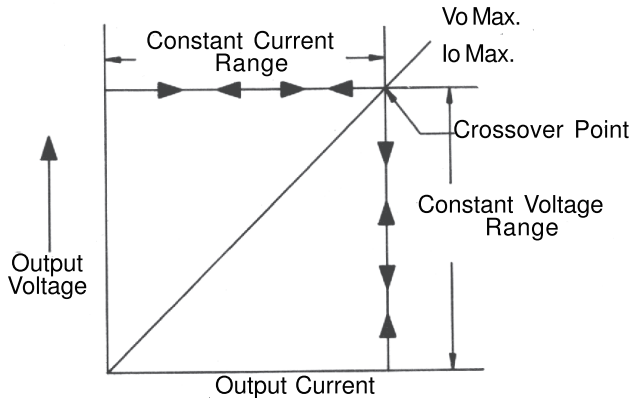

Figure 7 - Constant Voltage and Constant Current features.

Similarly, the crossover of the constant current to constant voltage occurs automatically with the load decreasing. A good example of this can be the load of a 12V battery. Initially the open circuit voltage of the power supply can be adjusted for 13.8V. A weak battery will behave as a high load and the power supply will operate in the constant current mode, that could be adjusted for 1A in example. After the complete battery charge, its voltage is close to 13.8V, the load to the source decreases until the point where it is not necessary a 1A current. This point is the crossover where the power supply will start to operate in the Constant Voltage mode and at this time the C.C indicator turns off and the C.V indicator turn on.

5.5 Single Operation Mode

1. Set the ON / OFF key to the position OFF.
2. Make sure that the power source voltage is equal to the selected voltage of the selection switch
3. Connect the power cable between the outlet and the power supply
4. Set the ON / OFF key to the position ON.
5. Adjust the voltage control (VOLTAGE) to the desired value. Remembers that the maximum current provided by the power supply is approximately 3A (UTP1303 and UTP3303) or 5A (UTP1305 and UTP3305).
6. Connect the output terminal to the load respecting the polarities (+) and (-), according to the following figure.

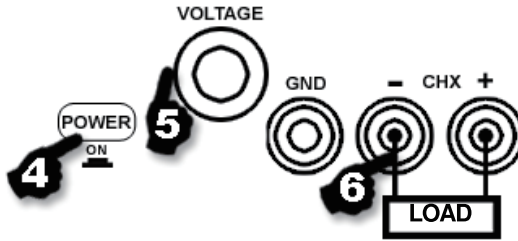

Figure 8 - Models UTP1303 and UTP1305 or each one of the adjustable power supplies of the Models UTP3303 and UTP3305 Connection.

Notes:

If you wish to adjust and limit current different of 3A or 5A, in each power supply, follow the procedures of the Limit Current Adjustment (anteriorly described). The above procedures can be performed individually for each one of the adjustable power supplies of the models UTP3303 and UTP3305, as well as for the models UTP1303 and UTP1305.

5.6 Parallel Operation Mode (available to UTP3303 and UTP3305)

1. Set the ON / OFF key to the position OFF.
2. Make sure that the power source voltage is equal to the selected voltage of the selection switch
3. Connect the power cable between the outlet and the power supply
4. Set the ON / OFF key to the position ON.
5. Press the both keys of the Connection Mode (tracking keys) to enter at the Parallel Operation Mode. In this work condition, it is possible to reach a limit current of approximately 6A (UTP3303) or 10A (UTP3305).
6. Adjust the voltage control (VOLTAGE) of the master power supply (CH1) to obtain the required voltage for the application. Remembers that the maximum current of each one of the power supplies can provide is about 3A (UTP3303) or 5A (UTP3305).
7. If necessary, adjust the current control (CURRENT) of the MASTER (CH1) power supply to obtain a different current of 3A (UTP3303) or 5A (UTP3305) in each power supply.
8. Connect the output terminal to the load respecting the polarities (+) and (-), according to the following figure.

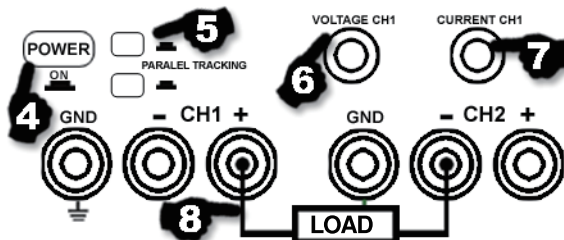

Figure 9 - Parallel Connection of the adjustable power supplies of the UTP3303 and UTP3305.

5.7 Series Operation Mode (available to UTP3303 and UTP3305)

1. Set the ON / OFF key to the position OFF.
2. Make sure that the power source voltage is equal to the selected voltage of the selection switch
3. Connect the power cable between the outlet and the power supply
4. Set the ON / OFF key to the position ON.
5. Press the TOP (CH1) key of the Connection Mode and keep the BOTTOM (CH2) key of the Connection Mode released to enter at the Series Operation Mode. In this work condition, it is possible to reach the maximum voltage of about 64V.
6. Adjust the voltage control (VOLTAGE) of the MASTER (CH1) power supply and then the sum of the Voltage Displays readings will be the total output voltage.
7. The current adjustment of the power supplies keeps independent, so normally keeps the SLAVE (CH2) power supply at the maximum and controls the current by the MASTER (CH1) current control.
8. Connect the output terminal to the load respecting the polarities (+) and (-), according to the following figure.

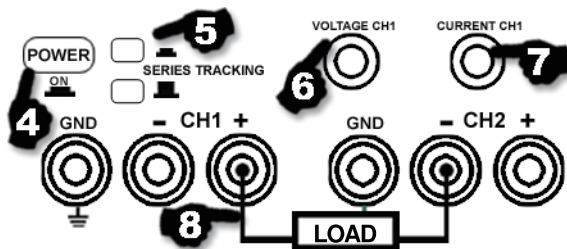

Figure 10 - Series Operation Mode of the adjustable power supplies of the models UTP3303 and UTP3305.

5.8 Symmetric Operation Mode (available to UTP3303 and UTP3305)

1. Set the ON / OFF key to the position OFF.
2. Connect a cable (preferable a short cable) between the negative output terminal (-) of the adjustable MASTER (CH1) power supply and the positive output terminal (+) of the adjustable SLAVE (CH2) power supply, as illustrated at the following figure.
3. Make sure that the power source voltage is equal to the selected voltage of the selection switch
4. Connect the power cable between the outlet and the power supply
5. Set the ON / OFF key to the position ON.
6. Press the TOP (CH1) key of Connection Mode and keep the BOTTOM (CH2) key of the Connection Mode released to enter in the Series Connection Mode. In this work condition, it is possible to obtain a common ground for both adjustable power sources, with maximum positive and negative output of +32V and -32V, respectively.
7. Adjust the voltage control (VOLTAGE) of the MASTER (CH1) power supply to obtain the negative and positive voltages.

8. The current adjustment of the power supplies keeps independent, so normally keeps the SLAVE (CH2) adjust at the maximum and controls the current by the MASTER (CH1) current control.
9. Connect the output terminal to the load respecting the polarities (+) and (-), according to the following figure.
10. After finish the operation, do not forget to unmake the connection between the power supplies.

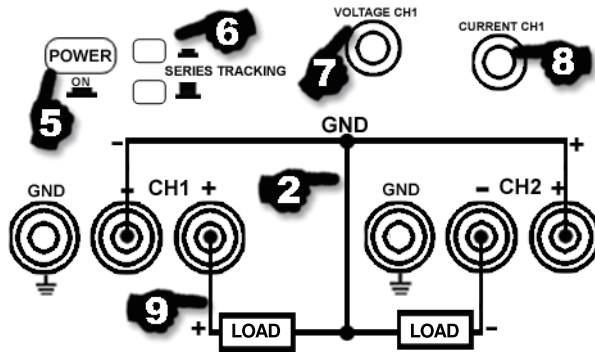

Figure 11 - Symmetric Connection of the adjustable power supplies of the models UTP3303 and UTP3305.

6. MAINTENANCE

⚠ Warning:

The procedures not included in this manual should be performed only by qualified personnel.

6.1 Fuse Replacement

If the input protection fuse burn, the power supply can not be turned on. Before the replacement, make sure that the power source cable and the connection cables are disconnected and that the power supply is turned off. The fuse does not burns unless we have a problem on instrument or operation. Hence, determine and correct the problem that induce the fuse blow and then replace it by another fuse with the same specifications, according to the following table. The fuse is located in the rear panel. Refers to Figures 3 and 4 at the Panel Description section.

Input Voltage	UTP1303	UTP1305	UTP3303	UTP3305
110/220V	250V / 3A	250V / 5A	250V / 5A	250V / 8A

6.2 Power Supply Voltage Selection

The power supplies supports operations with input voltage of 115V or 230V AC, 50/60Hz. The input voltage selection is realized by the position of the Power Supply Voltage Switch located in the rear panel. Refers to the Figures 3 or 4 of the Panel Description section.

1. Turn of the power supply and make sure that the power cable and the connection cable are disconnected.
2. Set the Power Supply Voltage Switch to the proper position, according to the power line voltage.
3. A power line alteration requires a fuse with the appropriate specification. Install the correct fuse according to the table of the Fuse Replacement section.

6.3 Cleaning

To clean the power supply use a soft cloth damped in a mild solution of water and neutral detergent.

- Never leave the water to enter inside the power supply.
- Do not use chemical product composed by: benzene, toluene, acetone or similar solvents.
- Do not use abrasive products in any area of the power supply.

7. ACCESSORIES

The instrument is supplied with the following accessories:

- Instruction Manual: 1 copy
- 4mm Banana / Alligator Jaw Cable Connection:
 - 1 pair (UTP1303 and UTP1305)
 - 2 pairs (UTP3303 and UTP3305)
- Power Cable: 1 piece

UNI-T[®]

UNI-TREND TECHNOLOGY (CHINA) CO., LTD.

No6, Gong Ye Bei 1st Road,
Songshan Lake National High-Tech Industrial
Development Zone, Dongguan City,
Guangdong Province, China
Tel: (86-769) 8572 3888
<http://www.uni-trend.com>

REV.1

DATE:2018-06-26

P/N:110401105747X